



Imperial Plastics, Inc
80 Industrial Street
Rittman, Ohio 44270
www.ip-inc.com

Note: This catalog contains examples of products that Imperial manufactures.
Not all of these parts are for resale as they may be considered proprietary.

Table of Contents

Flap Seals1

Flap Seals

Die: A1041

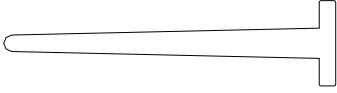

H:
W: 1.150
N: .312 base

Die: A1042



H:
W: 1.660
N: .300 base

Die: A1100



H: 1.000 flap
W: .145 base
N:

Die: A1165

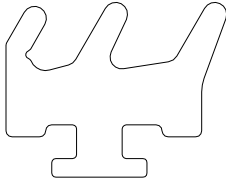

H:
W:
N:

Die: A1166

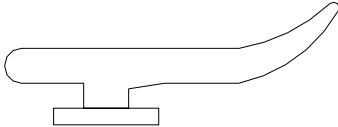

H:
W:
N:

Die: A1169

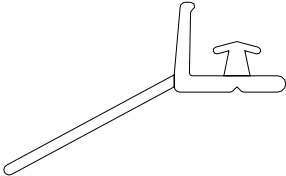

H:
W:
N:

Die: A119

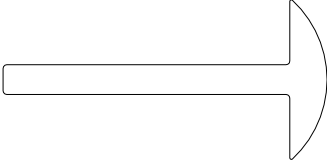

H:
W: .415
N: .205 base

Die: A276

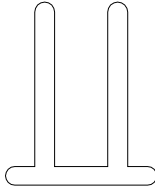

H: .345
W:
N: .275 base

Die: A282

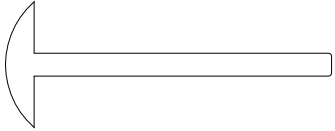

H:
W: .570
N: .220 base

Flap Seals

Die: A305



H:
W: .665
N: .095 fit

Die: A381

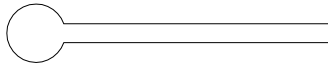

H:
W: .600
N: .103 base

Die: A567

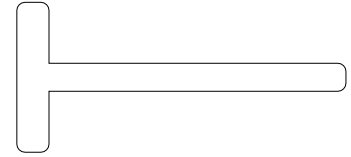

H:
W: .410
N: .187 base

Die: A580

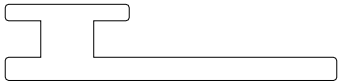

H: .135
W: .575
N: .213 base

Die: A596

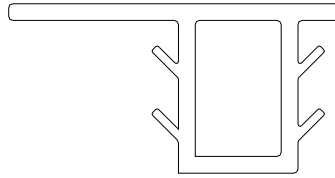

H: .390
W: .790 flap
N: .420 base

Die: A792

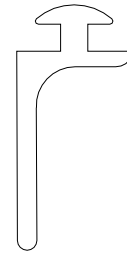

H: .500
W:
N: .230 base

Die: A816

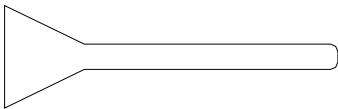

H: .035 wall
W: .460 flap
N: .140 base

Die: A829



H: .130
W: .625
N: .187 base

Die: A856

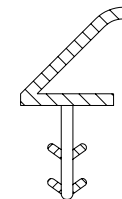

H: .500
W: .260 flap
N: .105 kerf fit

Flap Seals

Die: A864



H: .660
W: .155
N:

Die: A935

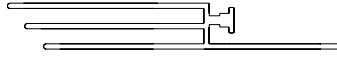

H:
W: 1.975
N: .170 base

Die: A943

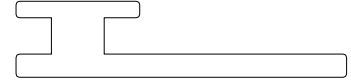

H: .125
W: .500
N: .187 base

Die: A971

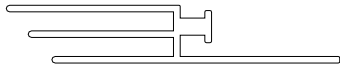

H: .305
W: 1.515
N: .170 base

Die: R627

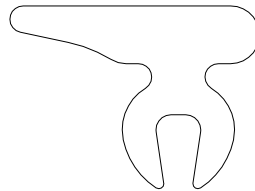

H:
W:
N: